

VAP*amore*



Patent Number D652185

MR100[®]
PRIMO

**STEAM CLEANER
INSTRUCTION BOOK AND USERS GUIDE**

SAFETY INFORMATION

GO TO VAPAMORE.COM TO SEE THE MR-100 PRIMO INSTRUCTIONAL VIDEO



WHEN USING THE STEAM CLEANER, BASIC SAFETY PRECAUTIONS SHOULD ALWAYS BE OBSERVED INCLUDING THE FOLLOWING

1. Do not leave the steam cleaner unattended when plugged in. Unplug it from socket when not in use.
2. To prevent electric shock use only with a grounded outlet.
3. Not to be used as a toy. Close supervision is necessary when used near children.
4. Use only as described in this manual.
5. Do not use with a damaged cord or plug. If the supply cord and/or plug is damaged, they must be replaced by Vapamore in order to prevent a fire hazard.
6. Do not pull or carry by the cord, use the cord as a handle, allow the cord to come into contact with hot or sharp surfaces or close a door on the cord.
7. Do not unplug by pulling on the cord.
8. Do not handle the plug or steam cleaner with wet hands.
9. Do not over pull or drag steam cleaner using the steam gun and hose.
10. Only carry the steam cleaner by the carry handle.
11. Turn off all controls before unplugging.
12. Steam cleaner must be level and on the floor during use.
13. Do not use an extension cord.
14. Do not attempt to remove blockages with sharp objects as they may cause damage.
15. Store indoors, put away after use to prevent tripping accidents.
16. Using improper voltage may result in damage to the steam cleaner and possible injury to the user. The correct voltage is listed on the label.
17. This steam cleaner is intended for household use only.
18. A hazard may occur if the steam cleaner runs over the power supply cord.
19. Do not over extend retractable cord past stopping point.
20. Never immerse the steam cleaner in water or other liquids.
21. Keep the steam cleaner away from rain and moisture. The steam cleaner is not suitable for outdoor use around water.
22. Only use the steam cleaner in containers / pools that are not filled with water or other liquids.
23. Do not operate the steam cleaner without water in the tank. Always top off with water when needed.
24. Only use distilled water. Using hard water will void the warranty and cause failure.
25. Never use additives such as perfumes, stain removers, or other chemicals in the water tank as they will void the warranty, cause permanent damage, and be dangerous.
26. Always remove the main plug from the socket and allow the steam cleaner to cool down completely before topping with water.
27. Do not overfill the tank. Do not exceed the maximum filling level. Please use the measuring jug and funnel included.
28. Make sure the water tank cap is fully tight and secure before use.
29. Empty the water tank if stored (See cleaning and storage).
30. Do not touch any hot areas on the steam cleaner. It is normal for the steam cleaner to heat up during operation.
31. Do not use the steam cleaner to treat any items of clothing that are still being worn on the body.
32. The force and heat of the steam may have an adverse effect on some materials. Always check whether a surface is suitable for treatment with the steam cleaner by carrying out a test beforehand on a concealed area.
33. Always include these operating instructions if passing the steam cleaner on to a third party.
34. Never aim the steam cleaner at people, animals or plants (risk of scalding)! Do not aim the steam cleaner at electrical systems.
35. Do not leave the steam cleaner on and unattended. Always switch the steam cleaner off and remove plug from wall outlet when unattended.
36. The steam cleaner is fitted with a thermostat and a thermal cut-out as protection against overheating.
37. Accessories become hot during use - allow them to cool down before handling.

PARTS OVERVIEW

GO TO VAPAMORE.COM TO SEE THE MR-100 PRIMO INSTRUCTIONAL VIDEO

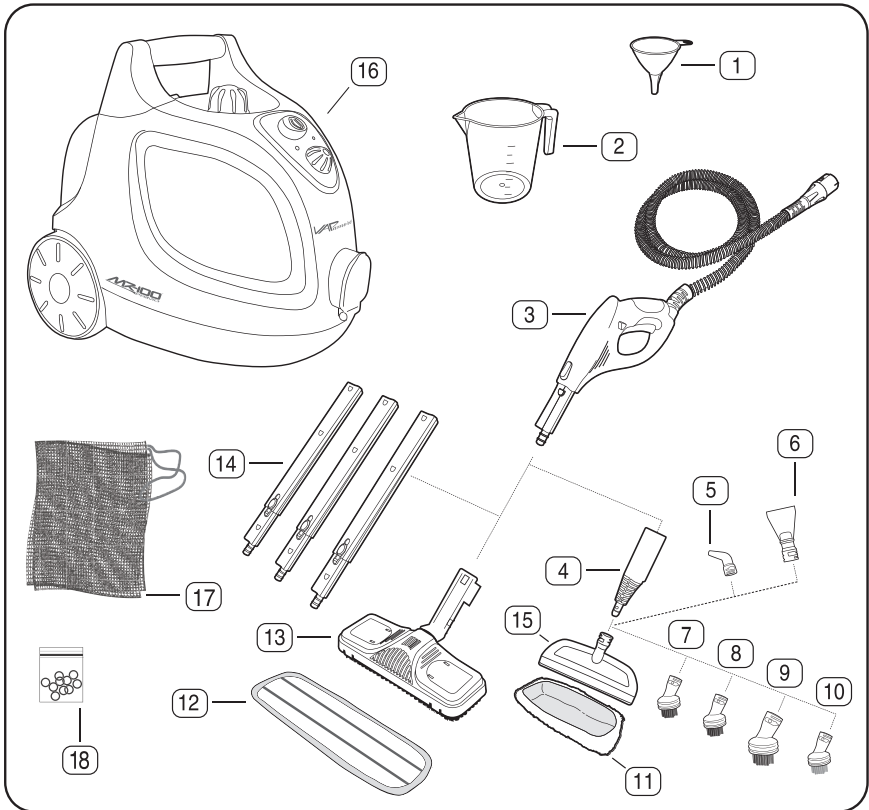

PARTS LIST

- 1 Funnel
- 2 Measuring cup
- 3 Steam gun with hose and connector
- 4 Detail adapter
- 5 Jet nozzle attachment
- 6 Detail scraper
- 7 Nylon grout brush
- 8 Nylon medium duty brush
- 9 Large nylon medium duty brush
- 10 Metal brush
- 11 Cotton cover
- 12 Micro fiber floor pad
- 13 Floor cleaning head
- 14 3 Extension tubes
- 15 Clothes / fabric - smooth surface tool
- 16 Steam cleaner
- 17 Accessory storage bag
- 18 Replacement o-ring set

TECHNICAL SPECIFICATIONS

Model: MR-100 Primo
Power supply: 120V 60Hz
Heating element power: 1500W
Steam pressure: 3.5 bar (max)
Permissible pressure: 5 bar
Volume of water tank: 1.6 litres (max)
Steam availability: 50 minutes
Heating time: Approx. 11 minutes
Steam flow rate: 40g /min (max)
Sound level: 30 dB(A) during use
Weight: Appliance without accessories 10.5lbs
Subject to technical change without notice.

STEAM CLEANER ASSEMBLY

GO TO VAPAMORE.COM TO SEE THE MR-100 PRIMO INSTRUCTIONAL VIDEO

⚠ IMPORTANT: Never unscrew the tank cap during use. The tank is under pressure.

Fig. 1

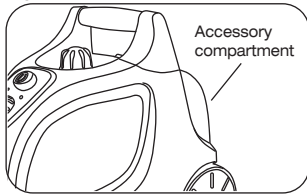

ACCESSORIES

The MR-100 Primo has an accessory compartment that houses the Detail adapter, Jet nozzle attachment, Clothes / fabric - smooth surface tool, and all brushes. Open the accessory compartment by pulling the accessory cover back - away from the machine. Remove the desired accessory from the accessory compartment and close the accessory cover.

(Fig.1)

Fig. 2

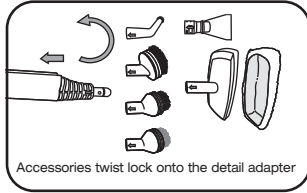

The detail adaptor is required when using all accessories. Attach by aligning the arrow on the accessory with the arrow on the detail adapter and twisting to lock in place. The detail adapter attaches directly to the steam gun and also can be attached to the extension tubes.

(Fig. 2 and 3)

Fig. 3

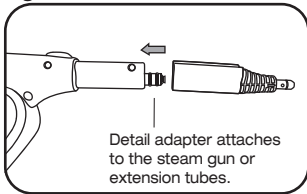

Connect the steam hose to the steam socket on the front of the steam cleaner. To do this flip down the dust cover door and push the connector on the steam hose firmly into the socket until both tabs click into place. To remove the steam hose, press in both release tabs located on the left and right side of the steam hose connector and pull out to release from the socket.

(Fig. 4)

Fig. 4

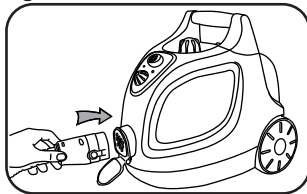
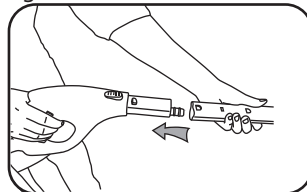

Fig. 5



EXTENTION TUBES

Assemble the extension tubes if the steam cleaner is to be used to clean floors or difficult to reach areas. To do this, push the open end of a tube onto the steam gun. Push it onto the steam gun until the release button of the steam gun clicks into place. Add one - three extension tubes as required

(Fig.5)

Fig. 6

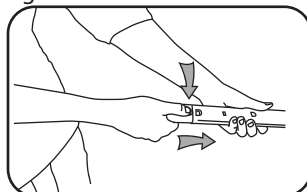

Press in the appropriate release button and pull the tubes apart with a downward movement to take the extension tube off again

(Fig.6)

FILLING & OPERATION

GO TO VAPAMORE.COM TO SEE THE MR-100 PRIMO INSTRUCTIONAL VIDEO

To fill the water tank, switch the steam cleaner off and remove the plug from the wall outlet. Allow steam cleaner to cool down before removing water tank cap. Unscrew the water tank cap (Fig.7) by pressing the cap down and simultaneously turning counter clockwise. Use the supplied funnel and the measuring cup filled to the top line marked 700ml two (2) times to equal 1.4 liters of water. (Fig.8)

Fig. 7

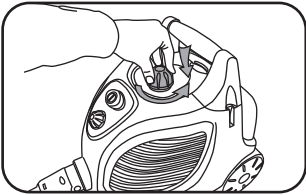

Replace the water tank cap by pressing down on the cap and simultaneously turning it clockwise. Make sure the cap is fully tight to prevent any steam from leaking out. If steam leaks from the cap area turn the Vapamore off and once cooled down tighten cap further.

⚠ IMPORTANT: Only fill with distilled water without additives of any kind, such as perfumes or cleaning agents. Using hard water will void the warranty and cause failure.

Fig. 8

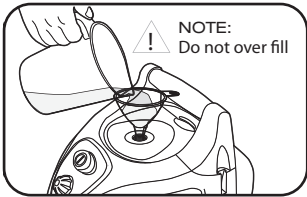

⚠ IMPORTANT: Do not exceed the maximum of 1.4 liters of water when filling the water tank. 1.4 liters is equal to filling the measuring cup to the 700ml mark two (2) times.

Plug the Vapamore into a proper wall outlet and switch to the on position by pressing the on / off switch. (Fig.9)

Fig. 9

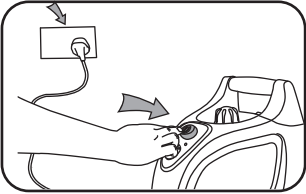

The red light will illuminate when the power button is depressed indicating the unit is heating. The green light will illuminate indicating the unit is fully heated and ready for use (approximately 11 minutes). The green light will cycle on and off with the heater to maintain full temperature during use. (Fig.10)

⚠ IMPORTANT: Never aim steam directly at people, animals, plants, or electrical systems. There is a risk of scalding or electrical shock.

Fig. 10

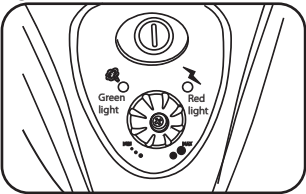

⚠ IMPORTANT: Always purge the residual water upon first operation after the machine has heated fully or between extended breaks in use. This will release the water that has accumulated in the lines of the machine. This is done by holding down the trigger and releasing the excess water into a rag or container.

Fig. 11

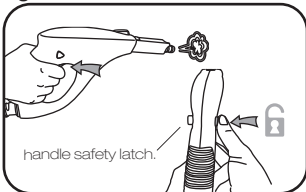

Release the locking device (child- proof device) by pushing the triangular pin on the right- hand side of the steam gun in towards the left (Fig. 11). Hot steam now escapes if the steam button is operated. Hold the steam gun over an old cloth to absorb any initial spray water. Operate the steam button until the steam is emitted evenly. Cleaning can now begin.

OPERATION

GO TO VAPAMORE.COM TO SEE THE MR-100 PRIMO INSTRUCTIONAL VIDEO

⚠ NOTE: Always test the steam cleaner first on inconspicuous or invisible areas of the surfaces or fabrics to be cleaned to check their tolerance to hot steam. Steam may result in bleaching of painted / varnished wood. Steam may discolor shiny plastics. Acrylic, velvet and linen react very sensitively to the hot steam.

⚠ NOTE: Vapamore cannot be held responsible for damage to objects, materials, people, animals or plants that occurs due to unsuitable use of hot steam or due to improper use of the appliance.

⚠ NOTE: The Vapamore is fitted with an overheating cut-out. The steam cleaner switches off automatically at a temperature of 250° f to prevent overheating.

Fig.12

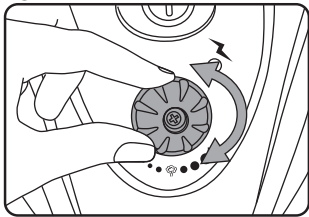

The flow rate of the steam emitted can be regulated by turning the steam controller and can be adjusted to the level required. Turn the steam controller clockwise for less steam and counter clockwise for more steam (Fig.12)

Do not tip or tilt the steam cleaner during use and ensure that the steamer is always on the floor or flat surface when in operation. A full tank is enough for a maximum of 50 minutes use. Do not leave the machine unsupervised while switched on and if necessary use the child- proof lock to secure the steam switch. To do this, press the triangular pin on the left- hand side of the steam gun in to the right.

⚠ IMPORTANT: The housing and accessories become hot during operation. Allow the steam cleaner to cool down before changing the accessories. Never open the tank cap while the steam cleaner is switched on as the tank is under pressure.

REFILLING WATER

The tank must be filled up if the steam flow emitted starts to decrease. Switch off the steam cleaner by pressing the on / off switch. The red operating pilot lamp goes off. Remove the main plug from the socket and allow the appliance to cool down for at least 15 minutes. Press the steam button on the steam gun to release the remaining pressure. Open the tank cap by pressing it down and turning it counter- clockwise.

⚠ WARNING: Hot steam may escape when opening the cap if the machine is not fully cooled off and / or all the remaining pressure is not released.

Add water using the measuring jug and funnel then carefully close the tank cap again. The steam cleaner can now be plugged in again and switched on. The steam cleaner is ready for use as soon as the green lamp turn on.

OPERATION

GO TO VAPAMORE.COM TO SEE THE MR-100 PRIMO INSTRUCTIONAL VIDEO

Fig.13

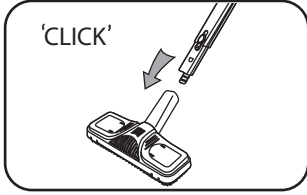

ACCESSORIES / FLOOR CLEANING HEAD

Attach the floor cleaning head to the end of the extension tube (use 1 to 3 tubes as desired). Ensure that the floor cleaning head clicks into place. (Fig.13)

The floor cleaning head can be used with or without the micro fiber cloth depending on the surface to be cleaned. Place the floor cleaning head on the micro fiber cloth and secure the overhanging material under the clips located on left and right side of the floor cleaning head. (Fig.14)

The floor cleaning head is ideal for tile, stone, vinyl, and wood floors along with cleaning washable walls and hard surfaces. It can also be used on carpet to sanitize, deodorize, kill allergens, bedbugs and dust mites. (Fig. 15) (Attach the micro fiber cover to allow the floor cleaning head to glide when using on carpet).

▲ **NOTE:** The steam gun, extension tubes, and floor cleaning head can be stored (as shown on the cover page of this instruction manual) by inserting the tab on the floor cleaning head into the slot located on the side of the Vapamore.

▲ **NOTE:** The steam gun, extension tubes, and floor cleaning head can be stored (as shown on the cover page of this instruction manual) by inserting the tab on the floor cleaning head into the slot located on the side of the Vapamore.

ACCESSORIES / DETAIL ADAPTOR

The detail adaptor can be attached directly to the steam gun or to any of the extension tubes. (Fig. 16)

The detail adaptor is needed in order to use the brushes, detail scraper clothes / fabric - smooth surface tool, and the jet nozzle attachment. To attach any of these accessories, Push the accessory onto the detail adaptor aligning the arrow on the accessory with the arrow on the detail adaptor. Twist the accessory on the detail adaptor to lock into place. Remove in the reverse order. (Fig.17)

The detail adaptor can also be used on its own as a straight jet nozzle tool or along with the 90 degree jet nozzle attachment. These tools are great for removing soap scum in the bath, shower and around faucets. Also for cleaning tight areas such as toilet hinges where high pressure steam can reach and blow out dirt and debris. This tool is most effective when applied direct to the surface being treated. The steam temperature will condense and cool within 1" of the jet tip. (Fig.18)

Fig.14

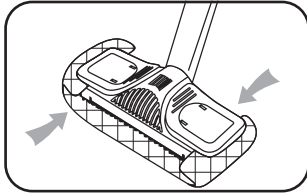

Fig.15

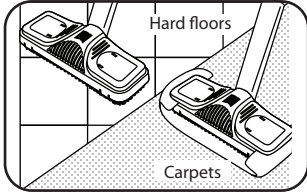

Fig. 16

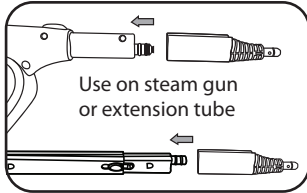

Fig. 17

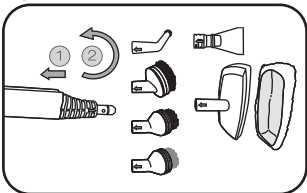
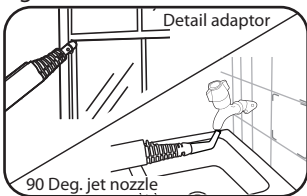

Fig. 18



OPERATION

GO TO VAPAMORE.COM TO SEE THE MR-100 PRIMO INSTRUCTIONAL VIDEO

Fig. 19

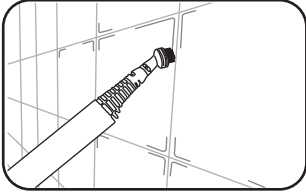

ACCESSORIES / BRUSHES

There are 4 brushes supplied with the Vapamore MR-100 Primo. The brushes attach to the detail adaptor by aligning the arrows and twisting to lock. Suggested uses (Metal brush), Oven grills, BBQ grates, cement stains, machinery, and metal surfaces. (Nylon medium duty and large nylon brush), used for more sensitive materials such as blinds, carpet, furniture, air vents, shoe scuffs, soap scum. (Nylon grout brush), this brush is used for harder less sensitive areas such as grout lines on tile floors, stone, cement, and machinery.

Fig.20

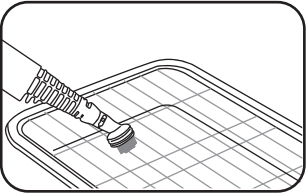

⚠ IMPORTANT : With all brushes it is important to not apply excessive pressure or force. This can cause failure of the detail adaptor or related parts. When using the brushes let the steam do the work and the brush to help agitate the stain or area being cleaned. (Fig. 19 /20)

Fig. 21

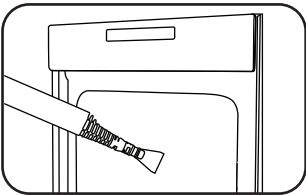

ACCESSORIES / SCRAPER

The scraper tool can be used to defrost freezers, on oven walls and cook top surfaces to remove stuck on food. This tool is also good for removing wall paper, paint and shelf paper. (Fig.21)

ACCESSORIES / CLOTHES - FABRIC TOOL

Fig. 22

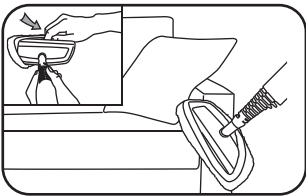

Start by installing the supplied cotton cover on the clothes - fabric / smooth surface tool. Now this tool can be used for steaming and sanitizing along with eliminating odors in garments, fabrics, furniture, curtains, drapes, etc.

BEDBUGS AND ALLERGENS

Use this tool on beading, pillows, and furniture by applying light pressure and slowly passing it along the surface to kill Bedbugs, dust mites and other allergens. (Fig.22)

Fig. 23



ACCESSORIES / SMOOTH SURFACE TOOL

Using the clothes - fabric / smooth surface tool without the cotton cover acts as a squeegee and is great for sanitizing kitchen and bathroom counter tops chemical free along with smooth surfaces such as stone, granite, wood, glass, tile and stainless steel. (Fig.23)

BEDBUG - DUST MITES - ALLERGENS

GO TO VAPAMORE.COM TO SEE THE MR-100 PRIMO INSTRUCTIONAL VIDEO

WHY USE STEAM?

The Vapamore MR-100 Primo produces steam with an output temperature between 210° to 220° degrees. Pests such as bedbugs, dust mites and other allergens along with their eggs are killed on contact at a temperature of 180° degrees. Using steam is an extremely effective and chemical free way to kill these pest along with E. Coli, Salmonella, H1N1 and other bacteria or viruses without leaving any harmful chemical residue behind. The tools supplied with the Vapamore MR-100 Primo allow you to treat all areas where these pests can hide such as bedding, sofas, furniture, pillows, carpet, cracks and crevices that are ideal hiding places for pests.

BEDDING / FURNITURE

Fig. 25

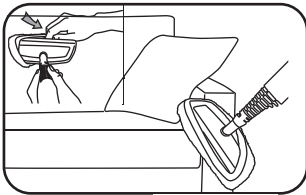

The clothes / fabric tool with the cotton cover is ideal for treating bedding, furniture, pillows, and carpet areas around bed posts and base boards. Start by installing the supplied cotton cover on the clothes - fabric / smooth surface tool. Apply light consistent pressure and slowly pass it along the surface (1" per second) to insure the area being treated has a chance to come to full temperature killing pests and their eggs. (Fig.25)

Fig.26

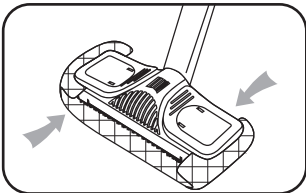

The floor cleaning head with micro fiber cover is also great for treating large surface areas such as bedding, furniture, and carpet areas. Start by installing the supplied micro fiber cover on the floor cleaning head. The micro fiber cover thermal core maintains full temperature during use and allows the floor cleaning head to glide over fabric or carpet. (Fig.26)

Fig.27

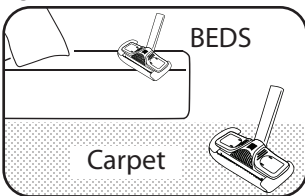

Apply light consistent pressure and slowly pass it along the surface (1" per second) to insure the area being treated has a chance to come to full temperature killing pests and their eggs. (Fig.27)

Fig.28

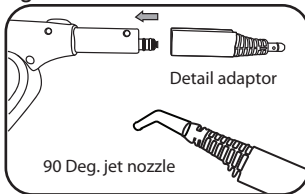

The detail adaptor can also be used on its own as a straight jet nozzle tool or along with the 90 degree jet nozzle attachment. These tools are great for cracks and crevices. Make sure to concentrate the steam directly on the area to be treated with as minimal distance as possible, no more than 1" away. The steam will condense and cool off and not be effective to kill pests and their eggs if the jet tip is not directly on the surface being treated. The detail adaptor can be attached directly to the steam gun or to any of the extension tubes. (Fig. 28)

CLEANING /STORAGE

GO TO VAPAMORE.COM TO SEE THE MR-100 PRIMO INSTRUCTIONAL VIDEO

CLEANING / MAINTENANCE

Always ensure before cleaning or maintaining the Vapamore MR-100 Primo that it is switched of and unplugged from the wall outlet. Only clean the outer surface with a slightly, water moistened cloth. Do not use any cleaning agents, abrasives or alcohol since they may damage the housing finish.

Lubricate the threads on the water tank cap with light oil or lubricating spray such as WD-40® once every 3 months or when needed.

The included micro fiber cover and cotton cover can be machine washed using normal detergents and wash cycle.

STORAGE

⚠ IMPORTANT : When storing the Vapamore, turn the machine off and unplug from the wall outlet. After the machine has cooled (aprox. 15 min), hold the steam gun trigger down to release the remaining steam pressure.

⚠ IMPORTANT: Only fill with distilled water without additives of any kind, such as perfumes or cleaning agents. Using hard water will void the warranty and cause failure.

Fig.24

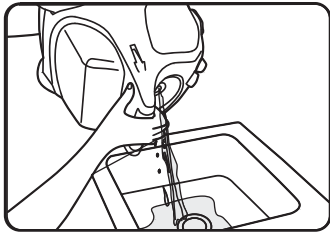

The tank should be emptied before storing for any extended period of time (30 days or more). To empty the tank, make sure the Vapamore is completely cooled down, remove the water tank cap and flip the Vapamore upside down to drain any remaining water from the tank. Leave the water tank cap off until the water tank is completely dry. (Fig.24)

ACCESSORIES

⚠ NOTE:The steam gun, extension tubes, and floor cleaning head can be stored (as shown on the cover page of this instruction manual) by inserting the tab on the floor cleaning head into the slot located on the side of the Vapamore.

Parts, extension tubes and accessories can also be stored in the supplied mesh storage bag.

Replacement accessories and parts are available to order online at vapamore.com or by calling Vapamore at 480-951-8900.

TROUBLESHOOTING

GO TO VAPAMORE.COM TO SEE THE MR-100 PRIMO INSTRUCTIONAL VIDEO

PROBLEM?

What do I do if the machine or an accessory becomes damaged or broken?
Visit www.vapamore.com for a complete list of parts and accessories available for purchase or simply call us at 480-951-8900 or E-mail us at info@vapamore.com to purchase replacement parts or schedule a repair. WE ARE HERE TO HELP..

⚠ IMPORTANT : Do not return to the place of purchase for warranty or repairs. Only Vapamore is authorized to facilitate all repairs to keep the highest quality and ETL standards. Repairs or tampering by any other party will void the Warranty.

TROUBLESHOOTING

PROBLEM: Operating pilot lamp fails to light.

Cause: The steam cleaner is not plugged into a socket or is not switched on.

Solution: Insert the main plug into a socket or switch the steam cleaner on.

Cause: The socket is faulty.

Solution: Check the socket by unplugging the steam cleaner and plugging in a different appliance.

Cause: One of the ETL protection devices has been triggered or the power cord has been damaged.

Solution: Call us at 480-951-8900 or E-mail us at info@vapamore.com to schedule a repair.

PROBLEM: No steam is emitted when the steam button is pressed.

Cause: The child proof lock is preventing release of the steam button.

Solution: Push the pin on the right- hand side of the steam gun inwards and to the left

Cause: The water tank is empty.

Solution: Fill in water.

PROBLEM: Only a very small amount of steam flows out.

Cause: The steam controller is set to minimum.

Solution: Turn the steam controller counter clockwise until sufficient steam is emitted.

PROBLEM: The steam cleaner takes a very long time to heat up.

Cause: The tank could have a build up of lime scale due to the use of hard water.

Solution: The tank must be de scaled by using a chemical de scaler . All chemicals must be removed from the water tank before the machine is operated. Anything other than 100% pure water inside the tank during operation could cause permanent failure of damage and can be very unsafe to operate.

NOTICE:

*To provide continued protection against risk of electric shock, connect to properly grounded outlets only. *Not for space heating purposes.

TIPS

GO TO VAPAMORE.COM TO SEE THE MR-100 PRIMO INSTRUCTIONAL VIDEO

APPLICATION	STEAM VOLUME	ATTACHMENT	TECHNIQUE
FLOORS / CHEMICAL FREE CLEANING WITH NO RESIDUE LEFT BEHIND			
Vinyl Tile Or Vinyl Sheet	Medium - High	Floor Cleaning Head + Micro fiber + Extension Tubes + Nylon Brush.	Sweep or vacuum first. Steam mop with floor cleaning head and micro fiber cover. Corners and baseboards with nylon brush.
Stone Tile, Slate, Ceramic Tile, Grout	High	Floor Cleaning Head + Micro Fiber + Extension Tubes + Nylon Brush + Grout Brush + Nylon Brush Jet Nozzle	Sweep or vacuum first. Steam mop with floor cleaning head, heavy stains use without micro fiber cover. Corners and baseboards with nylon brush. Grout lines use grout brush and / or jet nozzle. Finish with floor cleaning head / micro fiber cover.
Smooth Surface Concrete	High	Floor Cleaning Head + Micro Fiber + Extension Tubes + Grout Brush + Nylon Brush + Metal Brush + Jet Nozzle	Sweep or vacuum first. Steam mop with floor cleaning head, heavy stains use without micro fiber cover. Corners and baseboards with nylon brush. Joint lines use grout or metal brush and / or jet nozzle. Finish with floor cleaning head / micro fiber.
Hardwood	Low - Medium	Floor Cleaning Head + Micro Fiber + Extension Tubes	Sweep or vacuum first. Steam mop with floor cleaning head and micro fiber cover.
CARPETS / SPOT TREATMENT			
Wall To Wall, Rugs, Spot Care	High	Nylon Brush + Jet Nozzle + Paper Or White Cotton Towel	Vacuum area first then steam using brush or jet. Use towels to blot stain away. Chemical cleaner can be used prior to steam treatment.
CARPETS / DEOTERIZE + KILL BEDBUGS - DUST MITES AND ALLERGENS			
Wall To Wall, Rugs	High	Floor Cleaning Head + Extension tubes + Micro Fiber + Jet Nozzle	Vacuum area first then steam using floor cleaning head with micro fiber cover. Pass slowly over area to allow heat to kill pests. Use jet nozzle for corners and cracks.
WALLS, CEILINGS			
Painted, Wood Paneling, Wallpaper	Low - Medium	Floor Cleaning Head + Extension tubes + Micro Fiber + Nylon Brush + Clothes / Fabric tool with cotton cover.	Painted, wood paneling, wallpaper walls are heat sensitive. Always test small area first and be careful not to over heat finish. Use Floor Cleaning head with micro fiber cover or clothes steamer with cotton cover. Use nylon brush for corners and stains.
Wallpaper Removal	High	Nylon Brush, Jet Nozzle, Extension Tubes + Smooth Surface Tool + Scraper	Use at full power to soften glue and remove wallpaper. Wallpaper stripper can be applied first.
Air Vents	Medium -High	Nylon Brush, Jet Nozzle, Extension Tubes, Cotton Towel	Clean using brush and jet tip. Wipe down with clean cotton towel.
UPHOLSTERY / SPOT TREATMENT			
Vinyl, Synthetic, Cotton	Medium - High	Nylon Brush, Jet Nozzle, Clothes Steamer, Cotton Cover, Cotton Towel	Test a small area first. Some synthetic materials will not handle high heat. Use nylon brush with soft pressure for larger stains and jet tip for small stains. Blot with cotton towel. Use clothes steamer with cotton cloth to go over all surfaces to deoterize.
Leather	Low	Clothes Steamer, Cotton Cover, Cotton Towel	Test a small area first. Steam over stained area and then blot with cotton towel. Use clothes steamer with cotton cloth to go over all surfaces to deoterize.
UPHOLSTERY / KILL BEDBUGS - DUST MITES AND ALLERGENS			
Vinyl, Synthetic, Cotton	Medium - High	Jet Nozzle, Clothes Steamer, Cotton Cover	Test a small area first. Some synthetic materials will not handle high heat. Use clothes steamer with cotton cover and slowly pass over area to allow heat to kill pests. Use jet nozzle for cracks and corners.

TIPS

GO TO VAPAMORE.COM TO SEE THE MR-100 PRIMO INSTRUCTIONAL VIDEO

APPLICATION	STEAM VOLUME	ATTACHMENT	TECHNIQUE
WINDOW BLINDS			
Levolor, Venetian, Horizontal, Vertical	Low-Medium	Nylon Brush, Jet Nozzle, Detail Nozzle, Extension Tubes, Cotton Towel	Dust area first. Thin plastic blinds may not be able to handle heat from the steam. Test a small area first. Use jet or detail nozzle from 4" away. Wipe off with cotton towel.
GLASS			
Windows, Mirrors	Medium	Smooth Surface Squeegee, Extension Tubes, Nylon Brush, Paper Towels	Pre-steam glass from 6" away to heat glass. Use brush for edges and bases. Finish with window cleaner squeegee. Do not use if temperature is under 32 degrees to prevent cracking.
Window Screens, Window Frames	Medium -High	Detail Nozzle, Nylon Brush, Extension Tubes	Steam area with detail nozzle. Use brush for edges and corners.
KITCHENS			
Stove Tops, Ovens	Medium - High	Nylon Brush, Brass Brush, Extension Tubes, Paper towels	Use nylon brush over all surfaces and brass brush for interior oven grates. Wipe down with paper towels
Small Appliances	Medium	Nylon Brush, Detail Nozzle, Paper towels	Use brush over all areas and detail nozzle for small corners and seems. Wipe down with paper towels.
Sinks, Faucets, Drains	Medium - High	Nylon Brush, Detail Nozzle, Paper towels	Use brush over all areas and detail nozzle for small corners and seems. Wipe down with paper towels.
Counter Tops	Low- Medium	Smooth Surface Squeegee, Nylon Brush, Detail Nozzle, Paper towels	Use brush over all areas and detail nozzle for small corners and seems. Use smooth surace squeegee to sanitize counter tops by slowly passing over area then wipe area with paper towel for chemical free cleaning.
BATHROOM			
<small>(NOTE: HARD WATER AND CALCIUM STAINS CAN ONLY BE REMOVED WITH CHEMICALS.)</small>			
Tile, Grout	Medium - High	Floor Cleaning Head + Micro Fiber + Extension Tubes + Grout Brush + Jet Nozzle	Sweep or vacuum first. Steam mop with floor cleaning head, heavy stains use without cotton cover. Corners and baseboards with nylon brush. Grout lines use grout brush and / or jet nozzle .Finish with floor cleaning head with micro fiber.
Porcelain Toilets, Chrome Fixtures	Medium - High	Nylon Brush, Detail Nozzle, Paper towels	Use brush over all areas and detail nozzle for small corners, hinges, and seems. Wipe down with paper towels.
Shower, Tubs, Doors	Medium	Nylon Brush, Detail Nozzle, Extension Tubes, Paper towels	Use brush over all areas and detail nozzle for small corners and seems. Wipe down with paper towels.
AUTO, MOTORCYCLE, MARINE			
Interior Areas	Medium - High	Nylon Brush, Jet Nozzle, Clothes Steamer, Cotton Cover, Cotton Towel	Test a small area first. Some synthetic materials will not handle high heat. Use nylon brush with soft pressure for larger stains and jet tip for small stains. Blot with cotton towel.
Detailing, Exterior, Engine	Medium - High	Nylon Brush, Detail Nozzle, Jet Nozzle	Use brush over all areas and detail nozzle for small detail areas.

NEED HELP?

Visit www.vapamore.com to see video demonstrations and tips along with full details or simply call us at 480-951-8900 or E-mail us at info@vapamore.com
WE ARE HERE TO HELP..



Lifetime Limited Warranty for the Vapamore MR-100 Steam Cleaning System

Coverage:

1: Lifetime parts and labor on the boiler, heating element and all internal electronics.

The Vapamore MR-100 Steam Cleaning System boiler tank, heating element and all internal electronic parts are lifetime warranted to be free from defects in material and workmanship when utilized for normal household use by the original purchaser only.

2: One (1) year parts and labor on accessories and housing.

The Vapamore MR-100 Steam Cleaning System accessories and housing are warranted to be free from defects in material and workmanship for a period of one (1) year from the date of purchase when utilized for normal household use by the original purchaser only. This does not include replacement of items due to wear including but not limited to the Floor Brush, Nylon Brush, Grout Brush, Metal Brush, Jet tip, Clothes Steamer Cotton Cover, Floor Brush Cotton / Micro Fiber Cover.

For this warranty to apply the original purchaser must return the warranty registration form (included in the original packaging or available online at vapamore.com) along with a copy of the original purchase receipt to Vapamore 7464 East Tierra Buena Ln Suite 108 – Scottsdale, AZ 85260 within 15 days after the original purchase date.

Should any defect covered by the terms of this lifetime limited warranty be discovered, Vapamore will repair or replace any defective part provided the unit is returned by the original purchaser on file with the warranty form information.

The liability under this warranty is limited solely to the cost of the replacement parts or the complete unit at the discretion of Vapamore. This warranty is void if damage is resulting from accident, misuse, improper operation, unauthorized repair or alteration, tampering, substance other than distilled water used in the boiler tank, commercial or other than home use, or damages accruing in transit. This warranty does not cover any shipping fees to or from our facility.

This warranty is extended to the original purchaser only and excludes all other legal and / or conventional warranties. The responsibility of Vapamore, if any is limited to the specific obligations expressly assumed by it under the terms of the lifetime limited warranty. In no event is Vapamore liable for incidental or consequential damages of any kind whatsoever.

Customer is responsible for all shipping fees to and from our facility. Carefully pack returning items for repair to avoid damage in transit. Be sure to include in the box all your contact information including name, phone number, email address and shipping address along with a prepaid return ship tag from UPS or FedEx. Vapamore does not ship and will not accept items sent via USPS. Contact Vapamore at 480-951-8900 or email customersupport@vapamore.com for making arrangements to return items for repair or service. Vapamore is not responsible for any shipping cost to or from our facility.

VAPamore

tel. 480.951.8900 / fax. 480.951.8902

www.vapamore.com

