

VAP *amore*[®]

MR-75[™] AMICO



**STEAM CLEANER
INSTRUCTION BOOK AND USERS GUIDE**

SAFETY INFORMATION

GO TO VAPAMORE.COM TO SEE THE MR-75 AMICO INSTRUCTIONAL VIDEO



FAILURE TO FOLLOW SAFETY INFORMATION AND WARNINGS MAY CAUSE PERMANENT DAMAGE AND VOID PRODUCT WARRANTY.

1. Do not leave the steam cleaner unattended when plugged in. Unplug from socket when not in use.
2. To prevent electric shock use only with a grounded outlet.
3. Not to be used as a toy. Close supervision is necessary when used near children.
4. Use only as described in this manual.
5. Do not use with a damaged cord or plug. If the supply cord and/or plug is damaged, they must be replaced by Vapamore in order to prevent a fire hazard.
6. Do not pull or carry by the cord, use the cord as a handle, allow the cord to come into contact with hot or sharp surfaces or close a door on the cord.
7. Do not unplug by pulling on the cord.
8. Do not handle the plug or steam cleaner with wet hands.
9. Do not pull or drag steam cleaner using the steam gun and hose.
10. Only carry the steam cleaner by the handle.
11. Turn off all controls before unplugging.
12. Steam cleaner must be level and on the floor during use.
13. Do not use an extension cord.
14. Do not attempt to remove blockages with sharp objects as they may cause damage.
15. Store indoors, put away after use to prevent tripping accidents.
16. Using improper voltage may result in damage to the steam cleaner and possible injury to the user. The correct voltage is listed on the label.
17. Drain water tank prior to shipping, transporting.
18. A hazard may occur if the steam cleaner runs over the power supply cord.
19. Accessories become hot during use - allow them to cool down before handling.
20. Never immerse the steam cleaner in water or other liquids.
21. Keep the steam cleaner away from rain and moisture. The steam cleaner is not suitable for outdoor use around water.
22. Only use the steam cleaner in containers / pools that are not filled with water or other liquids.
23. Do not operate the steam cleaner without water in the tank. Always top off with water when needed.
24. Only use distilled water. Using hard water can cause calcium or mineral build up and void the warranty.
25. Never use additives such as perfumes, stain removers, or other chemicals in the water tank as they will void the warranty, cause permanent damage, and be dangerous.
26. Always remove the main plug from the socket and allow the steam cleaner to cool down completely before storage.
27. Do not overfill the tank. Do not exceed the maximum filling level. Please use the funnel included.
28. Make sure the water tank cap is fully secured before use.
29. Empty the water tank if stored (See cleaning and storage).
30. Do not touch any hot areas on the steam cleaner. It is normal for the steam cleaner to heat up during operation.
31. Do not use the steam cleaner to treat any items of clothing that are still being worn on the body.
32. The force and heat of the steam may have an adverse effect on some materials. Always check whether a surface is suitable for treatment with the steam cleaner by carrying out a test beforehand on a concealed area.
33. Always include these operating instructions if passing the steam cleaner on to a third party.
34. Never aim the steam cleaner at people, animals or plants (risk of scalding)! Do not aim the steam cleaner at electrical systems.
35. Do not leave the steam cleaner on and unattended. Always switch the steam cleaner off and remove plug from wall outlet when unattended.
36. The steam cleaner is fitted with a thermostat and a thermal cut-out as protection against overheating.

PARTS OVERVIEW

GO TO VAPAMORE.COM TO SEE THE MR-75 AMICO INSTRUCTIONAL VIDEO

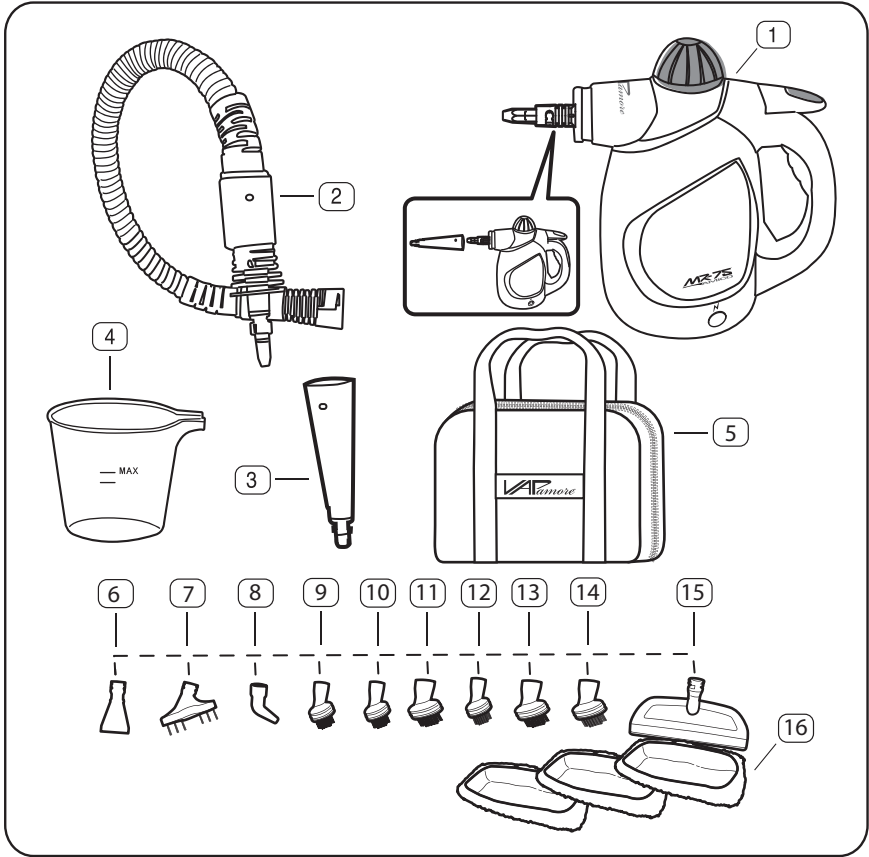

PARTS LIST

- 1 MR-75 Amico
- 2 Steam hose and connector
- 3 Accessory tool adapter
- 4 Measuring cup / funnel
- 5 Carrying case
- 6 Detail scraper
- 7 Nylon brush straight
- 8 Jet nozzle attachment
- 9 Nylon brush groud
- 10 Nylon brush medium
- 11 Nylon brush large
- 12 Metal brush small brass
- 13 Metal brush large brass
- 14 Metal brush large stainless steel
- 15 Clothes / fabric - Smooth surface squeegee
- 16 Cotton cover x 3

TECHNICAL SPECIFICATIONS

Model: MR-75 Amico
Power supply: 115 V - 60 Hz
Heating element: 1000 W - 10 A
Steam Pressure: 3 bar- 43.5 psi
Tank capacity: 200 ml - .21 qt
Heating time: 4 min.
Steam temp at tip: 99° C - 210° F
Power cord length: 10 ft
Gross weight: 1.58 kg - 3.5 lb

FILLING & OPERATION

GO TO VAPAMORE.COM TO SEE THE MR-75 AMICO INSTRUCTIONAL VIDEO

GENERAL FUNCTION: The MR-75 Amico steamer uses a heated boiler tank filled with water to create steam. When first plugged in you will see the red power light showing that the unit is powered on and heating. Once at full temperature the light will turn green showing the steamer is ready for use. This light will change back and forth from red to green during use as the heater cycles on and off. **The steamer can be used anytime after the initial heating and when the light is cycling between colors.** The steam pressure will fluctuate as the steamer is being used and the boiler cycles on and off during use.

⚠ **IMPORTANT:** Only fill with distilled water without additives of any kind, such as perfumes or cleaning agents. Using additives of any kind will void the warranty.

⚠ **IMPORTANT:** Only fill with distilled water. Using "hard" mineral heavy water will clog internal components and can cause failure to internal parts and void the warranty.

⚠ **IMPORTANT:** The housing and accessories become hot during operation. Allow the steam cleaner to cool down before changing the accessories.

⚠ **NOTE:** Always test the steam cleaner first on inconspicuous or invisible areas of the surfaces or fabrics to be cleaned to check their tolerance to hot steam. Steam may result in bleaching of painted / varnished wood. Steam may discolor shiny plastics. Acrylic, velvet and linen react very sensitively to the hot steam.

⚠ **NOTE:** Vapamore cannot be held responsible for damage to objects, materials, people, animals or plants that occurs due to unsuitable use of hot steam or due to improper use of the appliance.

Fig.1

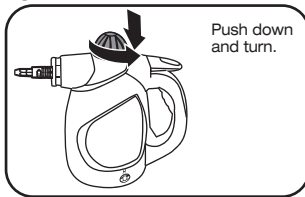

Always make sure the steamer is not plugged in and is cool before filling with water. If steamer is hot, allow steamer to cool down completely before removing water tank cap.

Unscrew the tank cap by pressing the cap down and simultaneously turning counter clockwise. Fig. 1

Fig.2

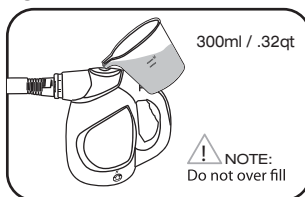

Use the supplied measuring cup filled with distilled water to the 200ml MAX line. Fig. 2

Replace the water tank cap by pressing down on the cap and simultaneously turning it clockwise. Make sure the cap is fully tight to prevent any steam from leaking out. If steam leaks from the cap area turn the Vapamore off and once cooled down tighten cap further.

Fig.3

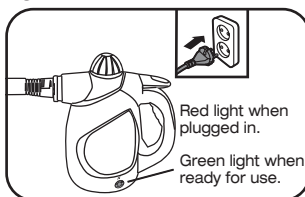

Plug in the steamer to a grounded 110 outlet. The steamer is ready for use. (Initial start up from cold machine is approx. 4 min) ***The status light will cycle red to green during use as the boiler maintains the temperature.** Fig. 3

STEAM CLEANER ASSEMBLY

GO TO VAPAMORE.COM TO SEE THE MR-75 AMICO INSTRUCTIONAL VIDEO

Fig. 4



Fig. 5

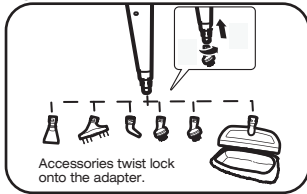

Fig. 6

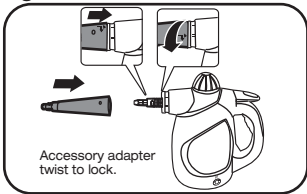

Fig. 7

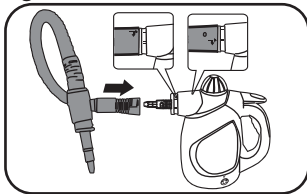

Fig. 8

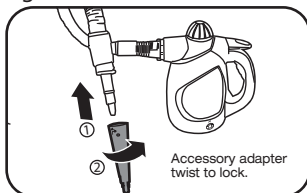
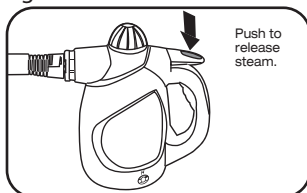

Fig. 9



⚠ IMPORTANT: Never unscrew the tank cap during use. The tank is under pressure.

ACCESSORIES

The MR-75 Amico has a full line of accessories that include the accessory tool adapter, jet nozzle attachment, clothes / fabric - smooth surface squeegee, detail scraper, steam hose and connector, carrying case and a full line of brushes.

The carrying case can be used to store and transport the MR-75 Amico and all the accessories and tools. Fig. 4

The accessory tool adaptor is required when using all accessories. Attach by aligning the arrow on the accessory with the arrow on the accessory tool adapter and twisting to lock in place. Fig. 5

The MR-75 Amico can be used with or without the steam hose.

For use without the steam hose, connect the accessory tool adapter directly to the MR-75 Amico by twisting to lock in place. All accessories can then be used with the accessory adapter. Fig. 6

For use with the steam hose, connect the steam hose directly to the MR-75 Amico by twisting to lock in place. There is a locking tab that will click to lock. To remove the steam hose, slide the locking tab and twist to remove. Fig. 7

Connect the accessory tool adapter to the steam hose by twisting to lock in place. All accessories can then be used with the accessory adapter. Fig. 8

Once the MR-75 Amico is ready for use, depress the steam trigger located on the top of the machine to release steam. Fig. 9

⚠ IMPORTANT: Always purge the residual water upon first operation after the machine has heated fully or between extended breaks in use. This will release the water that has accumulated in the lines of the machine. This is done by holding down the trigger and releasing the excess water into a rag or container.

OPERATION

GO TO VAPAMORE.COM TO SEE THE MR-75 AMICO INSTRUCTIONAL VIDEO

Fig. 10

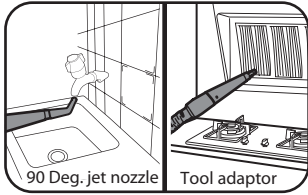

ACCESSORIES / DETAIL ADAPTOR

The accessory tool adaptor can also be used on its own as a straight jet nozzle tool or along with the 90 degree jet nozzle attachment. These tools are great for removing soap scum in the bath, shower and around faucets. Also for cleaning tight areas such as toilet hinges where high pressure steam can reach and blow out dirt and debris. This tool is most effective when applied direct to the surface being treated. The steam temperature will condense and cool within 1" of the jet tip. Fig. 10

Fig. 11

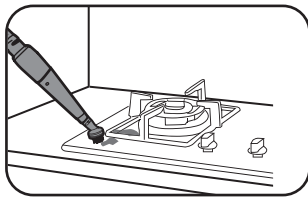

ACCESSORIES / BRUSHES

Suggested uses (Metal brush), oven grills, BBQ grates, cement stains, machinery, and metal surfaces. (Nylon medium duty and large nylon brush), used for more sensitive materials such as blinds, carpet, furniture, air vents, shoe scuffs, soap scum. (Nylon grout brush), this brush is used for harder less sensitive areas such as grout lines on tile floors, stone, cement, and machinery. Fig. 11 - 12

Fig. 12

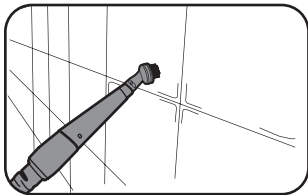

⚠ IMPORTANT : With all brushes it is important to not apply excessive pressure or force. This can cause failure of the detail adaptor or related parts. When using the brushes let the steam do the work and the brush to help agitate the stain or area being cleaned.

Fig. 13

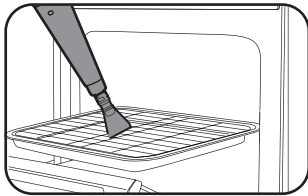

ACCESSORIES / SCRAPER

The scraper tool can be used to defrost freezers, on oven walls and cook top surfaces to remove stuck on food. This tool is also good for removing wall paper, paint and shelf paper along with removing gum from hard flooring. Fig. 13

Fig. 14

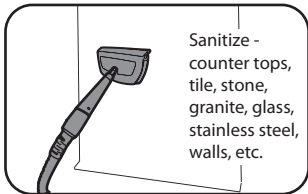

ACCESSORIES / SMOOTH SURFACE TOOL

Using the clothes - fabric / smooth surface tool without the cotton cover acts as a squeegee and is great for sanitizing kitchen and bathroom counter tops chemical free along with smooth surfaces such as stone, granite, wood, glass, tile and stainless steel. Fig. 14

OPERATION

GO TO VAPAMORE.COM TO SEE THE MR-75 AMICO INSTRUCTIONAL VIDEO

Fig. 15

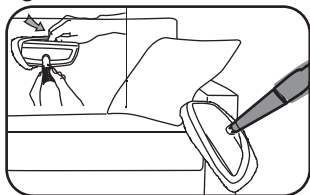

ACCESSORIES / CLOTHES - FABRIC TOOL

Start by installing the supplied cotton cover on the clothes - fabric / smooth surface tool. This tool can be used for steaming and sanitizing along with eliminating odors in garments, fabrics, furniture, curtains, drapes, etc. Fig. 15

BEDBUG - DUST MITES - ALLERGENS

The Vapamore MR-75 Amico produces steam with an output temperature between 200° to 210° degrees. Pests such as bedbugs, dust mites and other allergens along with their eggs are killed on contact at a temperature of 180° degrees. Using steam is an extremely effective and chemical free way to kill these pest along with E. Coli, Salmonella, H1N1 and other bacteria or viruses without leaving any harmful chemical residue behind. The tools supplied with the Vapamore MR-75 Amico allow you to treat all areas where these pests can hide such as bedding, sofas, furniture, pillows, carpet, cracks and crevices that are ideal hiding places for pests.

CLOTHES - FABRIC TOOL

The clothes / fabric tool with the cotton cover is ideal for treating bedding, furniture, pillows, and carpet areas around bed posts and base boards. Start by installing the supplied cotton cover on the clothes - fabric / smooth surface tool. Apply light consistent pressure and slowly pass it along the surface (1" per second) to insure the area being treated has a chance to come to full temperature killing pests and their eggs. Fig. 15

ACCESSORY TOOL ADAPTER

Fig. 16

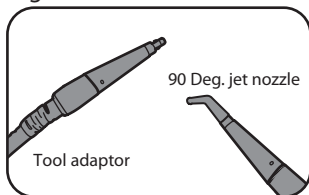

The tool adaptor can also be used on its own as a straight jet nozzle tool or along with the 90 degree jet nozzle attachment. These tools are great for cracks and crevices. Make sure to concentrate the steam directly on the area to be treated with as minimal distance as possible, no more than 1" away. The steam will condense and cool off and not be effective to kill pests and their eggs if the jet tip is not directly on the surface being treated. The detail adaptor can be attached directly to the steam gun or to any of the extension tubes. Fig. 16

NOTE: Replacement accessories and parts are available to order online at vapamore.com or by calling Vapamore at 480-951-8900.

REFILL / CLEANING / STORAGE

GO TO VAPAMORE.COM TO SEE THE MR-75 AMICO INSTRUCTIONAL VIDEO

REFILLING WATER

The tank must be filled up when the steam flow emitted starts to decrease. Turn off the MR-75 Amico by unplugging from the wall outlet. The red operation pilot light will be off. Allow the unit to cool down for at least 15 minutes. Press the steam trigger to release any remaining steam pressure. Open the tank cap by pressing down and turning counter - clockwise.

⚠ WARNING: Hot steam may escape when opening the cap if the machine is not fully cooled off and / or all the remaining pressure is not released.

Add water using the measuring cup / funnel then carefully close the tank cap again by pressing down and turning clockwise until fully tight. The MR-75 Amico can now be plugged in. The unit is ready for use as soon as the red pilot light turns to green.

CLEANING / MAINTENANCE

Always ensure before cleaning or maintaining the Vapamore MR-75 Amico that it is unplugged from the wall outlet. Only clean the outer surface with a slightly, water moistened cloth. Do not use any cleaning agents, abrasives or alcohol since they may damage the housing finish.

Lubricate the threads on the water tank cap with light oil or lubricating spray such as WD-40 once every 3 months or when needed.

The included small cotton covers can be machine washed using normal detergents and wash cycle.

STORAGE

⚠ IMPORTANT : When storing the MR-75 Amico, unplug from the wall outlet and let the unit cool down. After the unit has cooled, hold the steam trigger down to release any steam pressure remaining.

Fig. 17

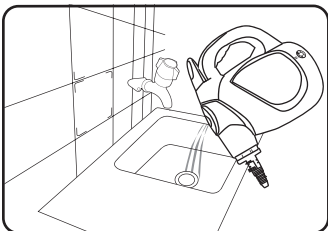

The tank should be emptied before storing for any extended period of time (30 days or more). To empty the tank, make sure the MR-75 is completely cooled down, remove the water tank cap and flip the Vapamore upside down to drain any remaining water from the tank. Leave the water tank cap off until the water tank is completely dry. Fig. 17

TROUBLESHOOTING

GO TO VAPAMORE.COM TO SEE THE MR-75 AMICO INSTRUCTIONAL VIDEO

PROBLEM?

What do I do if the machine or an accessory becomes damaged or broken?
Visit www.vapamore.com for a complete list of parts and accessories available for purchase or simply call us at 480-951-8900 or E-mail us at info@vapamore.com to purchase replacement parts or schedule a repair. WE ARE HERE TO HELP..

⚠ IMPORTANT : Do not return to the place of purchase for warranty or repairs. Only Vapamore is authorized to facilitate all repairs to keep the highest quality and ETL standards. Repairs or tampering by any other party will void the Warranty.

TROUBLESHOOTING

PROBLEM: Operating pilot lamp fails to light.

Cause: The steam cleaner is not plugged into a socket.

Solution: Insert the main plug into a socket.

Cause: The socket is faulty.

Solution: Check the socket by unplugging the steam cleaner and plugging in a different appliance.

Cause: One of the ETL protection devices has been triggered or the power cord has been damaged.

Solution: Call us at 480-951-8900 or E-mail us at info@vapamore.com to schedule a repair.

PROBLEM: No steam is emitted when the steam button is pressed.

Cause: The water tank is empty.

Solution: Fill in water.

PROBLEM: Only a very small amount of steam flows out.

Cause: The water tank is low or empty.

Solution: Refill the water tank.

PROBLEM: The steam cleaner takes a very long time to heat up.

Cause: The tank could have a build up of lime scale due to the use of hard water.

Solution: The tank must be de scaled by using a chemical de scaler . All chemicals must be removed from the water tank before the machine is operated. Anything other than 100% pure water inside the tank during operation could cause permanent failure of damage and can be very unsafe to operate.

NOTICE:

*To provide continued protection against risk of electric shock, connect to properly grounded outlets only *Not for space heating purposes



Lifetime Limited Warranty for the Vapamore MR-75 Amico Steam Cleaner

Coverage:

1: Lifetime parts and labor on the boiler, heating element and all internal electronics.

The Vapamore MR-75 Amico Steam Cleaner boiler tank, heating element and all internal electronic parts are lifetime warranted to be free from defects in material and workmanship when utilized for normal household use by the original purchaser only.

2: One (1) year parts and labor on accessories and housing.

The Vapamore MR-75 Amico Steam Cleaner accessories and housing are warranted to be free from defects in material and workmanship for a period of one (1) year from the date of purchase when utilized for normal household use by the original purchaser only. This does not include replacement of items due to wear including but not limited to the Nylon Brush, Grout Brush, Metal Brush, Jet tip, Clothes Steamer Cotton Cover, Scraper.

For this warranty to apply the original purchaser must return the warranty registration form (included in the original packaging or available online at vapamore.com) along with a copy of the original purchase receipt to Vapamore 7464 East Tierra Buena Ln Suite 108 – Scottsdale, AZ 85260 within 15 days after the original purchase date.

Should any defect covered by the terms of this lifetime limited warranty be discovered, Vapamore will repair or replace any defective part provided the unit is returned by the original purchaser on file with the warranty form information.

The liability under this warranty is limited solely to the cost of the replacement parts or the complete unit at the discretion of Vapamore. This warranty is void if damage is resulting from accident, misuse, improper operation, unauthorized repair or alteration, tampering, substance other than distilled water used in the boiler tank, commercial or other than home use, or damages accruing in transit. This warranty does not cover any shipping fees to or from our facility.

This warranty is extended to the original purchaser only and excludes all other legal and / or conventional warranties. The responsibility of Vapamore, if any is limited to the specific obligations expressly assumed by it under the terms of the lifetime limited warranty. In no event is Vapamore liable for incidental or consequential damages of any kind whatsoever.

Customer is responsible for all shipping fees to and from our facility. Carefully pack returning items for repair to avoid damage in transit. Be sure to include in the box all your contact information including name, phone number, email address and shipping address along with a prepaid return ship tag from UPS or FedEx. Vapamore does not ship and will not accept items sent via USPS. Contact Vapamore at 480-951-8900 or email customersupport@vapamore.com for making arrangements to return items for repair or service. Vapamore is not responsible for any shipping cost to or from our facility.

Vapamore®
tel. 480.951.8900 / fax. 480.951.8902
www.vapamore.com

